



## Comair Rotron Specification Sheet

Specification Date: Nov 28, 2017

Version: 01

RoHS Compliant

COMAIR ROTRON PART NUMBER:

19039850A

COMAIR ROTRON MODEL NUMBER:

DD692712K1A

---

### A.) MOTOR:

RATED VOLTAGE:	12 Vdc
OPERATING VOLTAGE RANGE:	8 Vdc – 16 Vdc
LOW-START VOLTAGE:	8 Vdc
RUNNING CURRENT:	4.7 Amps
RATED POWER:	56.4 Watts
NOMINAL SPEED:	3200 RPM ± 200 (At Free Delivery)
START UP TIME:	10 Seconds Maximum
MOTOR TYPE:	Brushless DC
MOTOR PROTECTION:	By Integrated Circuit, Fuse
LOCKED ROTOR PROTECTION:	Electronic
POLARITY PROTECTION:	Yes
AUTOMATIC RESTART CAPABILITY:	By Integrated Circuit
ROTATION:	Clockwise when viewed from Inlet

### B.) MECHANICAL

DIMENSIONS:	175 mm Dia. x 69 mm (6.9" Dia. x 2.7") <i>Figure 1</i>
WEIGHT:	1.1 Kg (2.41 Lbs.)
BEARING TYPE:	Ball Bearing, Permanently Lubricated, Shielded
MOTOR BASE:	Cast Aluminum
IMPELLER:	Steel Metal, painting after color zinc



# Comair Rotron Specification Sheet

Specification Date: Nov 28, 2017

Version: 01

RoHS Compliant

COMAIR ROTRON PART NUMBER:

19039850A

COMAIR ROTRON MODEL NUMBER:

DD692712K1A

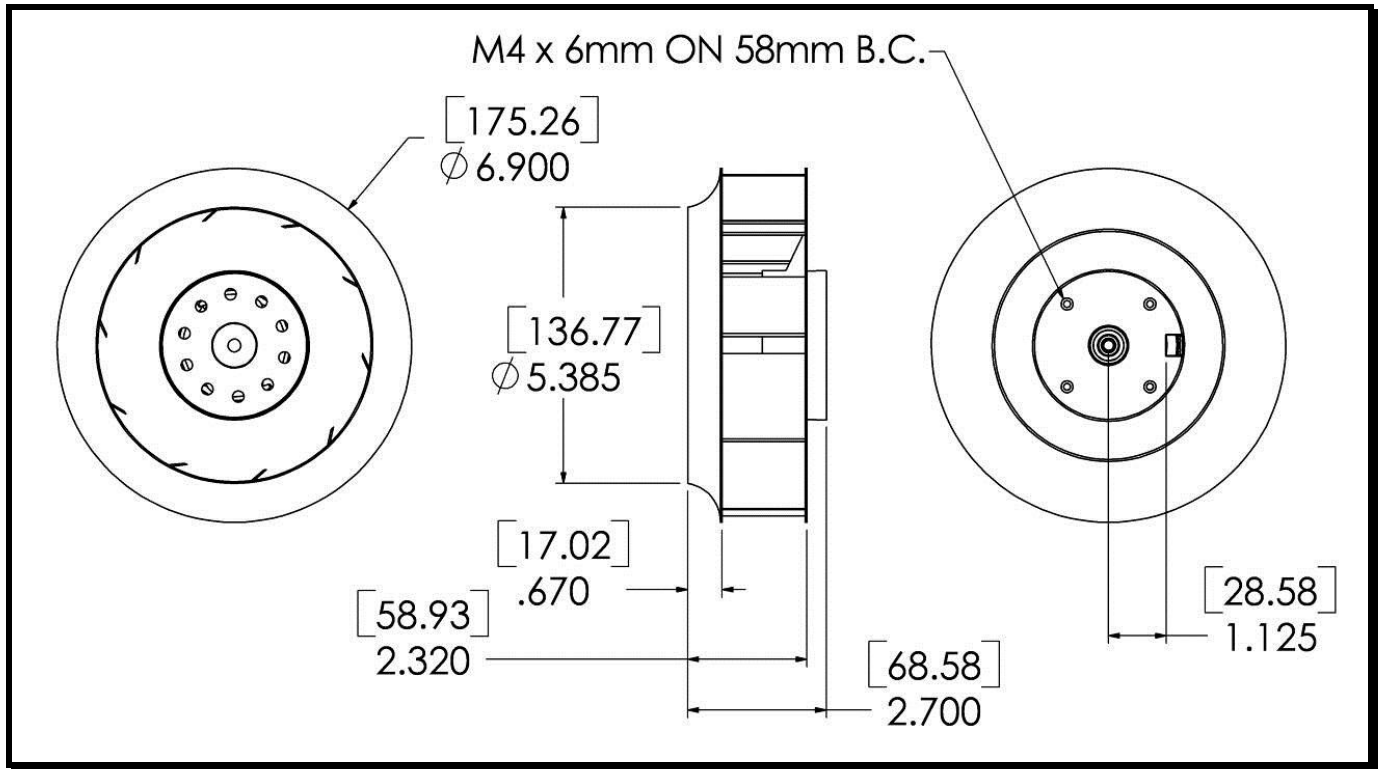

Figure 1

## C.) ADDITIONAL FEATURES

TACHOMETER OUTPUT:

5Vdc TTL Compatible Output  
 $I_c = 5\text{mA}$  typical.  
 2 Pulses per Revolution

## D.) ENVIRONMENTAL

OPERATING TEMPERATURE:

-10°C to 70°C

STORAGE TEMPERATURE:

-40°C to +85°C

HUMIDITY:

5% to 95% RH, non-condensing

VIBRATION:

3G's (20 to 200 Hz)

SHOCK:

100G peak, 10 msec, half sine wave



# Comair Rotron Specification Sheet

Specification Date: Nov 28, 2017

Version: 01

RoHS Compliant

COMAIR ROTRON PART NUMBER:

19039850A

COMAIR ROTRON MODEL NUMBER:

DD692712K1A

## E.) PERFORMANCE CHARACTERISTICS

AIR FLOW:

332 CFM  $\pm$  10%  
(Measuring at zero static pressure)

STATIC PRESSURE:

1.50" Inches of H<sub>2</sub>O  
(Measuring at zero air flow)

ACOUSTIC LEVEL:

68.8 dBA  
(Freely Suspended at 1 meter per  
ANSI S12.11-1987)

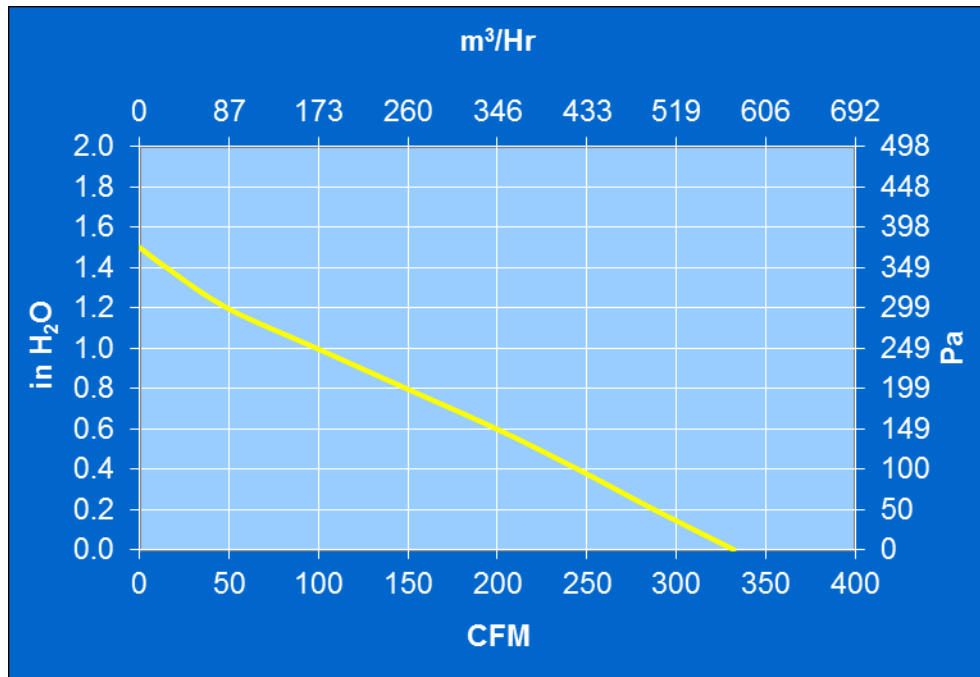

Figure 2

## F.) TERMINATION

LEADWIRES:

304.8 mm  $\pm$  25.4 mm (From the motor edge  
to the tip of the connector)  
18 AWG, UL 1061 Style

COLOR DESIGNATION:

Red – Power (+)  
Black – Return (-)  
Blue/White – Tachometer Output



## Comair Rotron Specification Sheet

Specification Date: Nov 28, 2017

Version: 01

RoHS Compliant

COMAIR ROTRON PART NUMBER:

19039850A

COMAIR ROTRON MODEL NUMBER:

DD692712K1A

---

### G.) RELIABILITY

This fan is designed for continuous duty life of 55,000 Hours at 40°C, (L10)

### H.) SAFETY

UL, CUL, CE

### I.) Flammability

The all components of the motorized impeller meet a UL94V-0 rating or better.