



Comair Rotron Specification Sheet

Specification Date: Mar 06, 2017

Version: 00

RoHS Compliant

COMAIR ROTRON PART NUMBER:

17000284A

COMAIR ROTRON MODEL NUMBER:

DD692748Z1A

A.) MOTOR:

RATED VOLTAGE:	48 Vdc
OPERATING VOLTAGE RANGE:	36 Vdc – 60 Vdc
LOW-START VOLTAGE:	36 Vdc
RUNNING CURRENT:	1.13 Amps
RATED POWER:	54.1 Watts
NOMINAL SPEED:	3400 RPM \pm 200 (At Free Delivery)
START UP TIME:	10 Seconds Maximum
MOTOR TYPE:	Brushless DC
MOTOR PROTECTION:	By Integrated Circuit, Fuse
LOCKED ROTOR PROTECTION:	Electronic
POLARITY PROTECTION:	Yes
AUTOMATIC RESTART CAPABILITY:	By Integrated Circuit
ROTATION:	Clockwise when viewed from Inlet

B.) MECHANICAL

DIMENSIONS:	175 mm Dia. x 69 mm (6.9" Dia. x 2.7") <i>Figure 1</i>
WEIGHT:	1.1 Kg (2.41 Lbs.)
BEARING TYPE:	Ball Bearing, Permanently Lubricated, Shielded
MOTOR BASE:	Cast Aluminum
IMPELLER:	Steel Metal, painting after color zinc



Comair Rotron Specification Sheet

Specification Date: Mar 06, 2017

Version: 00

RoHS Compliant

COMAIR ROTRON PART NUMBER:

17000284A

COMAIR ROTRON MODEL NUMBER:

DD692748Z1A

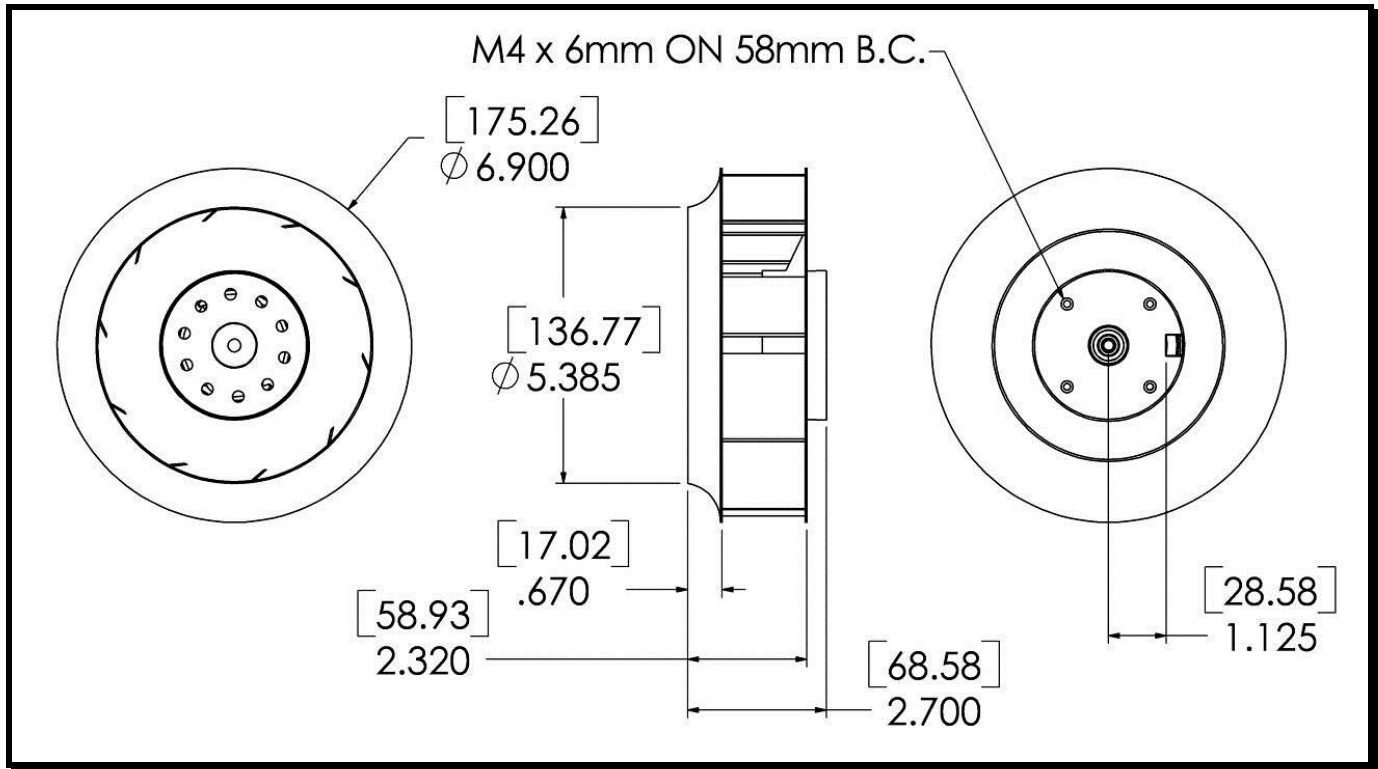

Figure 1

C.) ADDITIONAL FEATURES

TACHOMETER OUTPUT:

5Vdc TTL Compatible Output
 $I_c = 5\text{mA}$ typical.
 2 Pulses per Revolution

D.) ENVIRONMENTAL

OPERATING TEMPERATURE:

-10°C to 70°C

STORAGE TEMPERATURE:

-40°C to +85°C

HUMIDITY:

5% to 95% RH, non-condensing

VIBRATION:

3G's (20 to 200 Hz)

SHOCK:

100G peak, 10 msec, half sine wave



Comair Rotron Specification Sheet

Specification Date: Mar 06, 2017

Version: 00

RoHS Compliant

COMAIR ROTRON PART NUMBER:

17000284A

COMAIR ROTRON MODEL NUMBER:

DD692748Z1A

E.) PERFORMANCE CHARACTERISTICS

AIR FLOW:

353 CFM \pm 10%

(Measuring at zero static pressure)

STATIC PRESSURE:

1.69" Inches of H₂O

(Measuring at zero air flow)

ACOUSTIC LEVEL:

70.1 dBA

(Freely Suspended at 1 meter per ANSI S12.11-1987)

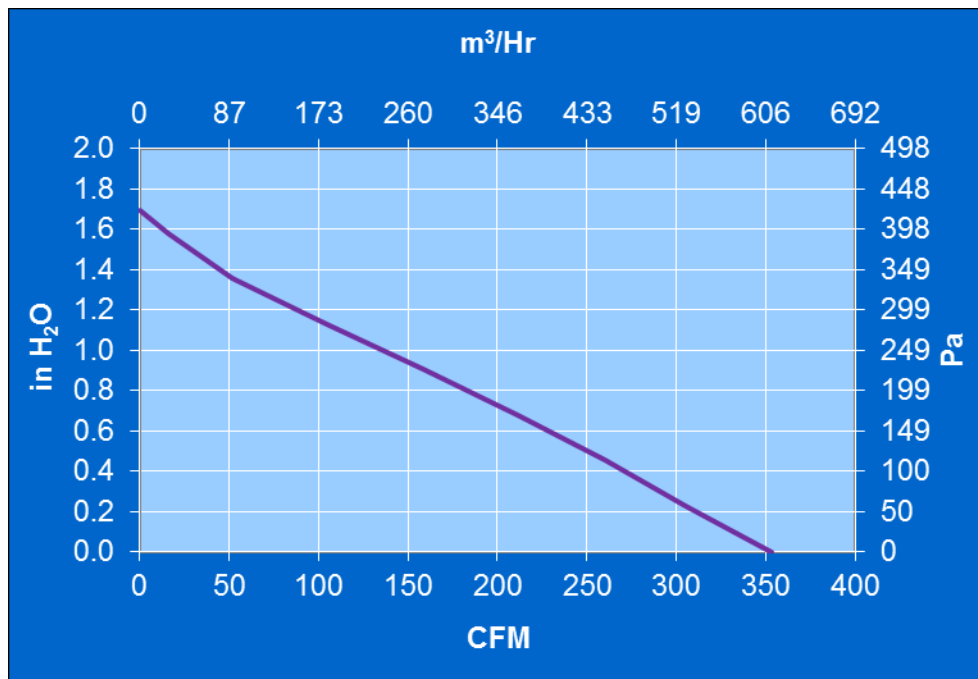

Figure 2

F.) TERMINATION

LEADWIRES:

304.8 mm \pm 25.4 mm (From the motor edge to the tip of the connector)

22 AWG, UL 1061 Style

COLOR DESIGNATION:

Red – Power (+)

Black – Return (-)

Blue/White – Tachometer Output



Comair Rotron Specification Sheet

Specification Date: Mar 06, 2017

Version: 00

RoHS Compliant

COMAIR ROTRON PART NUMBER:

17000284A

COMAIR ROTRON MODEL NUMBER:

DD692748Z1A

G.) RELIABILITY

This fan is designed for continuous duty life of 55,000 Hours at 40°C, (L10)

H.) SAFETY

UL, CUL, CE

I.) Flammability

The all components of the motorized impeller meet a UL94V-0 rating or better.