

SPECIFICATIONS

(RoHS Compliant)



Model Number: SPDD12K1
Part Number: 17000301A

Version: 00
Dec 02, 2017

Mechanical Drawing:

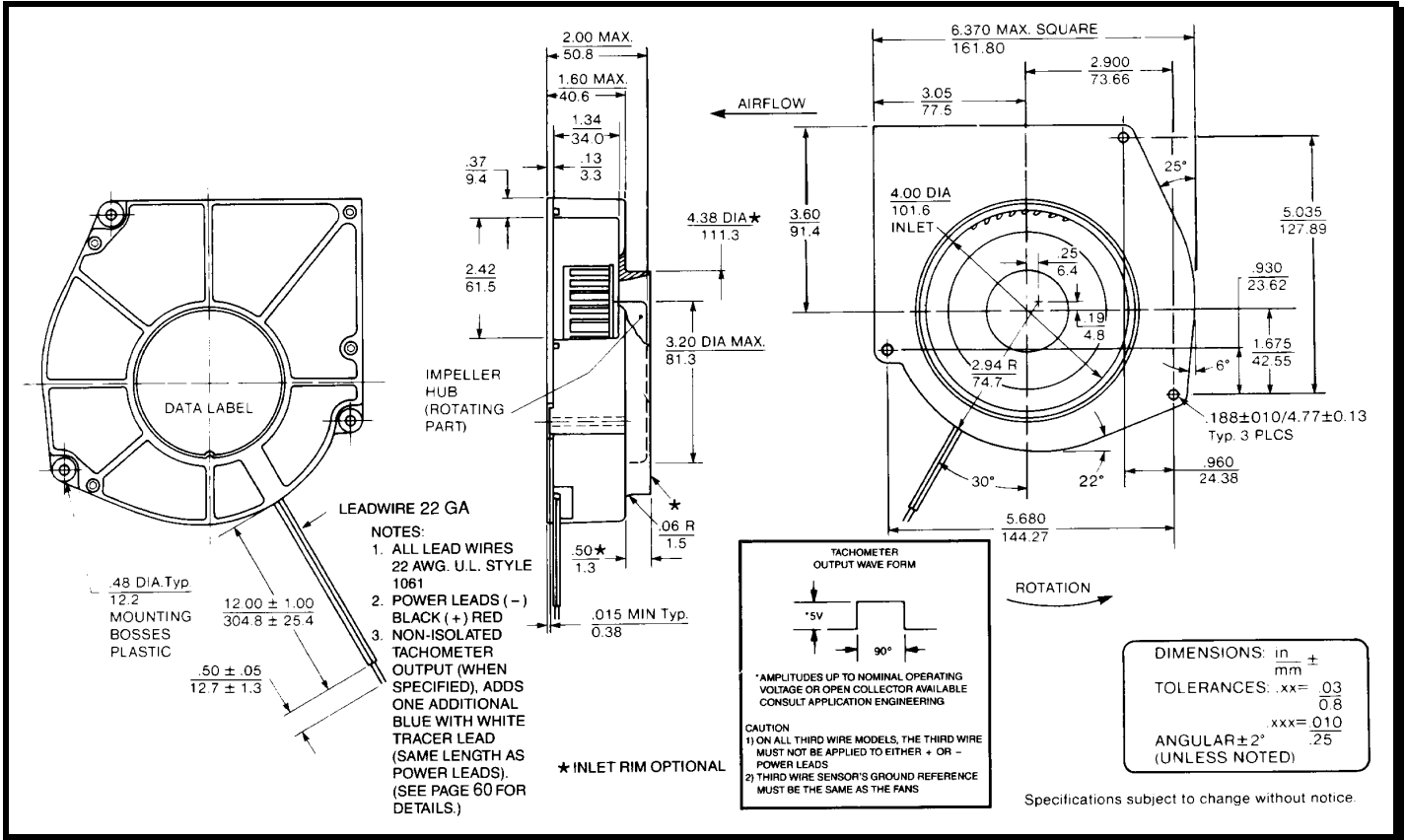

Specifications:

Nominal Voltage	= 12 vdc
Operating Voltage Range	= 8 - 16 vdc
Nominal Running Current	= 6.3 amps
Locked Rotor Current	= 7.5 amps
Running Power	= 75.3 watts
Average Speed	= 4000 rpm
Bearings	= Ball
Air Flow	= 100.5CFM
Noise	= 67.2 dBA

Construction:

Backplate: Die-Cast Zinc Alloy
 Housing & Propeller: Polycarbonate, Black, meets UL94V-0 flammability rating.

Life Expectancy:

This fan is designed for continuous duty life of 45,000 hours at 70°C.

Features:

- Polarity Protected
- Brushless DC Motor Design
- Electronic Locked Rotor Protection
- Automatic Restart Capability
- Operating Temperature: -10°C to 70 °C
- Storage Temperature: -40°C to 85°C

Termination:

- 12" Lead wires, 18 AWG, UL 1061
- Red - Power
- Black - Return

Agency Approvals:

UL, CUL, CE

PQ Curve:

