

# SPECIFICATIONS



**Model Number:** WD48H3  
**Part Number:** 17000271A

**Rev:** 00  
**Sep 20, 2017**

## Mechanical Drawing:

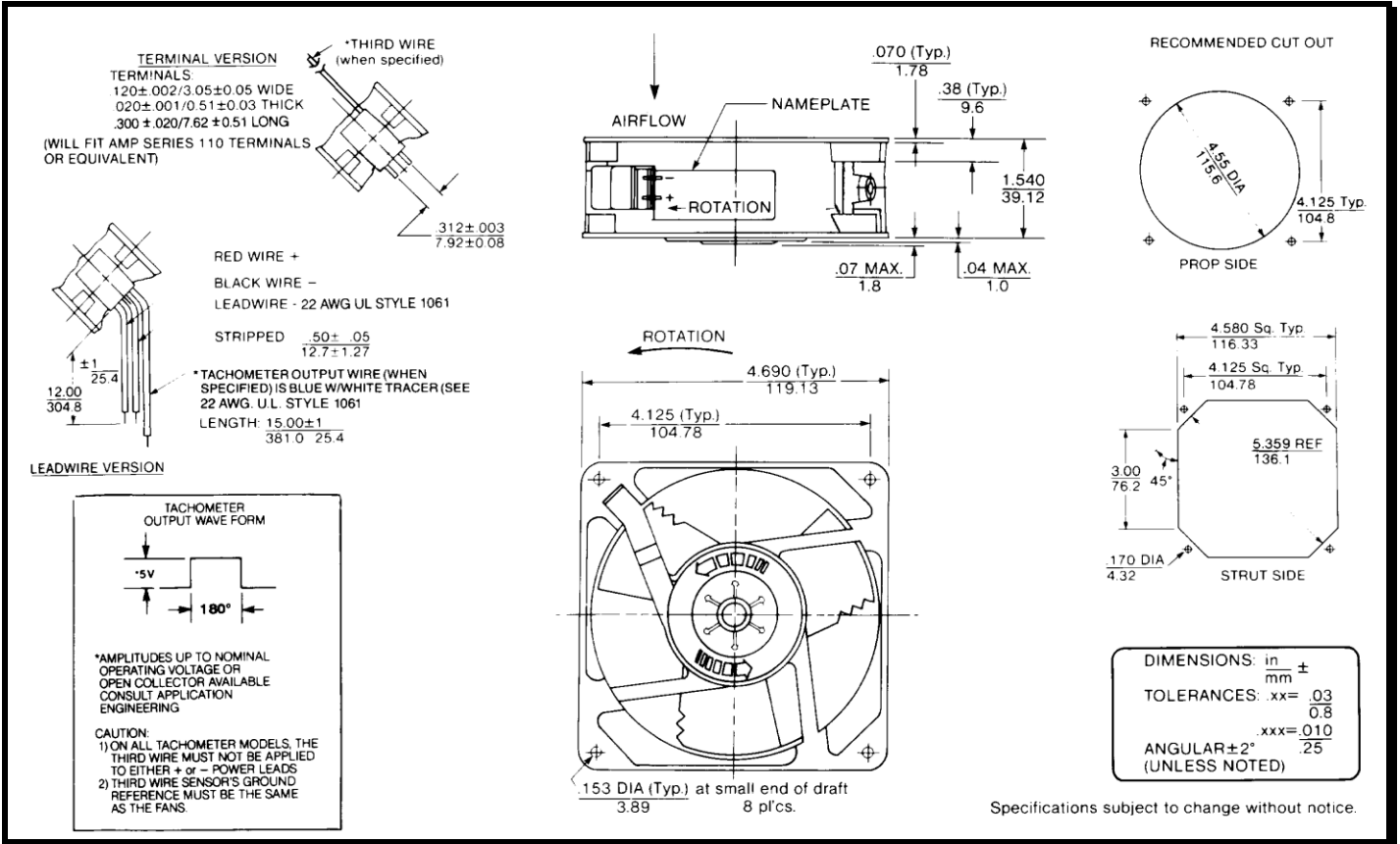

### Motor:

Nominal Voltage = 48 vdc  
 Operating Voltage Range = 24 – 56 vdc  
 Nominal Running Current = 0.04amps  
 Locked Rotor Current = 0.30 amps  
 Running Power = 1.9 watts  
 Average Speed = 1950 RPM  
 Bearings = Ball  
 Air Flow = 65 CFM  
 Acoustic = 34.9 dBA

### Construction:

Venturi: Die-Cast Aluminum, Black  
 Propeller: Plastic, Black, UL 94V-0

### Life Expectancy:

This fan is designed for continuous duty life of 83,000 hours at 40°C.

### Additional Features:

Brushless DC Motor  
 Locked Rotor Protection  
 Polarity Protection  
 Automatic Restart Capability  
 Operating Temperature: -10°C to 70°C  
 Storage Temperature: -40°C to 85°C

### Termination:

12" Lead wires, 22 AWG, UL 1061  
 Red = Power (+)  
 Black = Ground (-)

### Agency Approvals:

UL, CUL, CE

**PQ Curve:**

