

SPECIFICATIONS



Model Number: WT12Z3
Part Number: 19031544A

Version: 01
August 8, 2015

Mechanical Drawing:

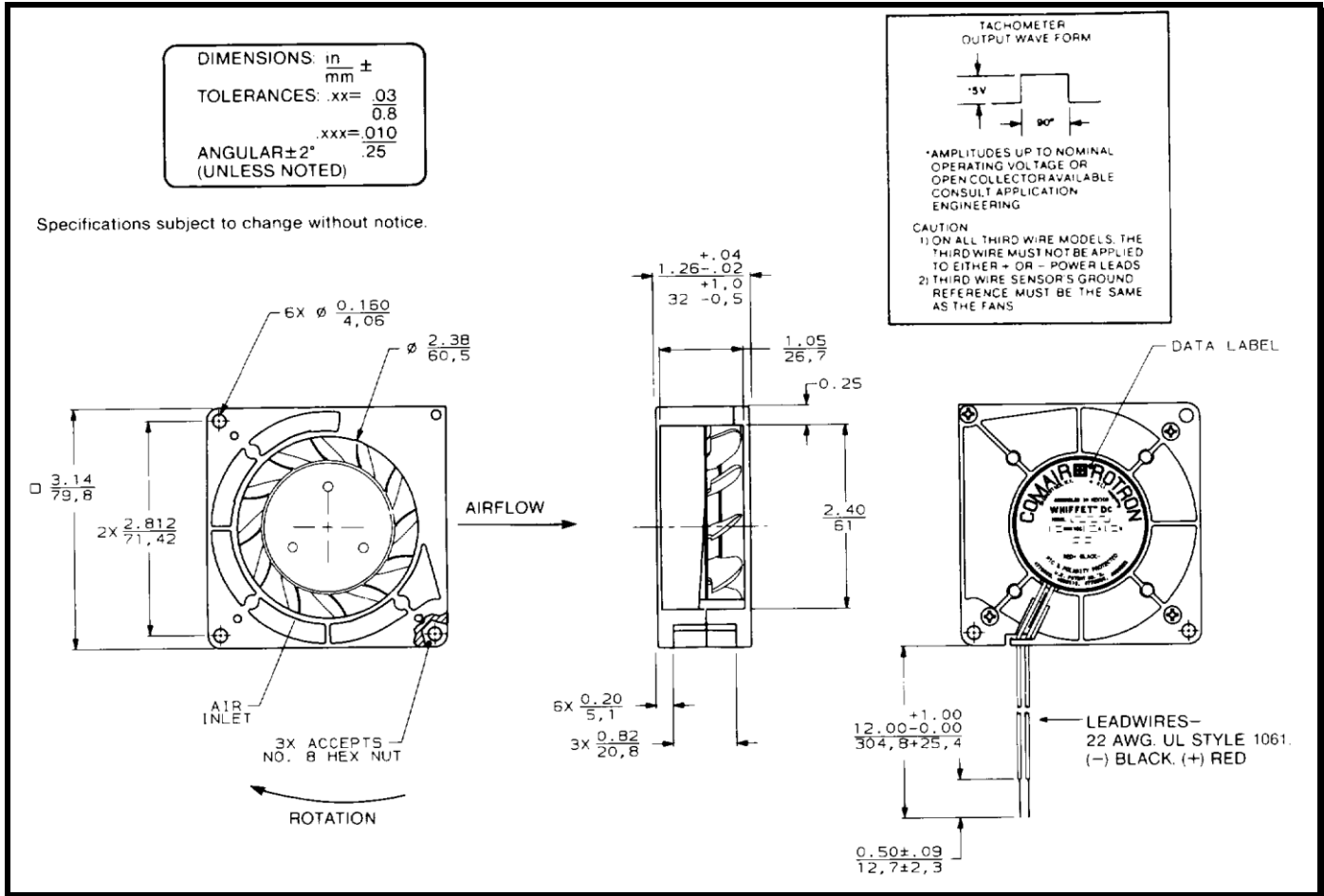

Motor:

Nominal Voltage	= 24 vdc
Operating Voltage Range	= 12 - 28 vdc
Nominal Running Current	= 0.43 amps
Max. Locked Rotor Current	= 1.0 amps
Running Power	= 10.3 watts
Average Speed	= 5300 RPM
Bearings	= Ball
Air Flow	= 19.6 CFM
Acoustic	= 57.3 dBA

Construction:

Venturi: Plastic, Black, UL 94V-0
 Propeller: Plastic, Black, UL 94V-0

Life Expectancy:

This fan is designed for continuous duty life of 55,000 hours at 70°C.

Additional Features:

Brushless DC Motor
 Locked Rotor Protection
 Reverse Polarity Protected
 Automatic Restart Capability
 Operating Temperature: -10°C to 70°C
 Storage Temperature: -40°C to 85°C

Termination:

12" Lead wires, 22 AWG, UL 1061
 Red = Fan Power (+)
 Black = Fan Ground (-)

Agency Approvals:

UL, CUL, CE

PQ Curve:

