



## Comair Rotron Specification Sheet

Specification Date: Dec 08, 2017

Version: 01

COMAIR ROTRON PART NUMBER: 19039824A  
COMAIR ROTRON MODEL NUMBER: DD402124K1R

---

### A.) MOTOR:

RATED VOLTAGE:	24 Vdc
OPERATING VOLTAGE RANGE:	12 Vdc – 32 Vdc
LOW-START VOLTAGE:	12 Vdc
RUNNING CURRENT:	1.33 Amps
LOCKED ROTOR CURRENT:	3.5 Amps
RATED POWER:	31.9 Watts
NOMINAL SPEED:	5900±10% RPM (At Free Delivery)
START UP TIME:	8 Seconds Maximum
MOTOR TYPE:	Brushless DC
MOTOR PROTECTION:	By Integrated Circuit, Fuse
LOCKED ROTORT PROTECTION:	Electronic
POLARITY PROTECTION:	Yes
AUTOMATIC RESTART CAPABILITY:	By Integrated Circuit
ROTATION:	Clockwise when viewed from Inlet

### B.) MECHANICAL

DIMENSIONS:	101.51mm Dia. x 55.6mm (4.0" Dia. x 2.19") <i>Figure 1</i>
WEIGHT:	0.37 Kg (0.82 Lbs.)
BEARING TYPE:	Ball Bearing, Lubricated, Shielded
MOTOR BASE:	Aluminum
PROPELLER:	Plastic



# Comair Rotron Specification Sheet

Specification Date: Dec 08, 2017

Version: 01

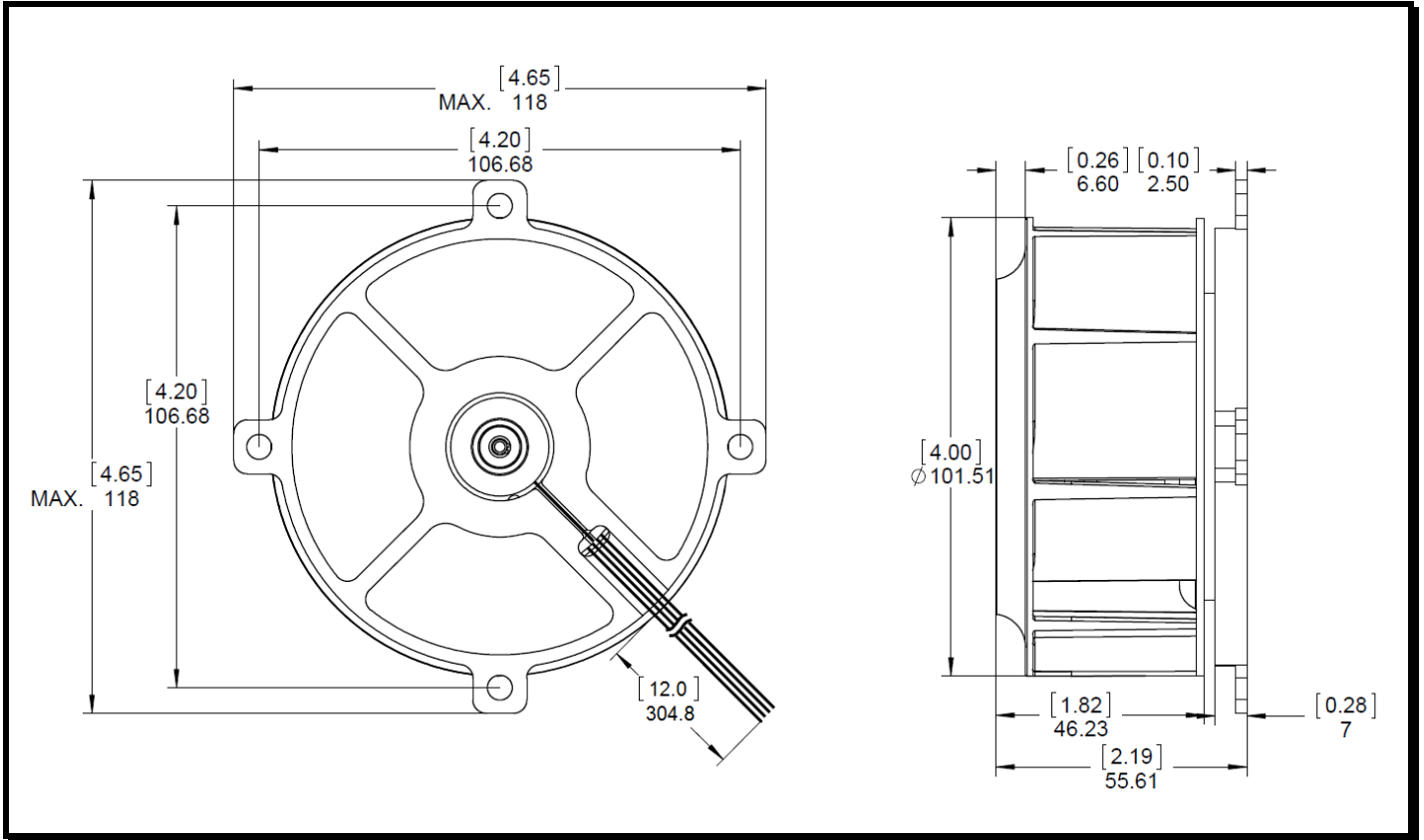

Figure 1

## C.) ADDITIONAL FEATURES

TACHOMETER OUTPUT:

5Vdc TTL Compatible Output

$I_C = 5\text{mA typ.}$

1 Pulse per Revolution

## D.) ENVIRONMENTAL

OPERATING TEMPERATURE:

-10°C to 70°C

STORAGE TEMPERATURE:

-40°C to 85° C,

HUMIDITY:

5% to 95% RH, non-condensing

VIBRATION:

3G's (20 to 200 Hz)

SHOCK:

100G peak, 10 msec, half sine wave



## Comair Rotron Specification Sheet

Specification Date: Dec 08, 2017

Version: 01

### E.) PERFORMANCE CHARACTERISTICS

AIR FLOW: 116 CFM  $\pm$  10%  
(Measuring at zero static pressure)

STATIC PRESSURE: 1.73" Inches of H<sub>2</sub>O  
(Measuring at zero airflow)

ACOUSTIC LEVEL: 67.0 dBA  
(Freely Suspended at 1 meter per ANSI S12.11-1987)

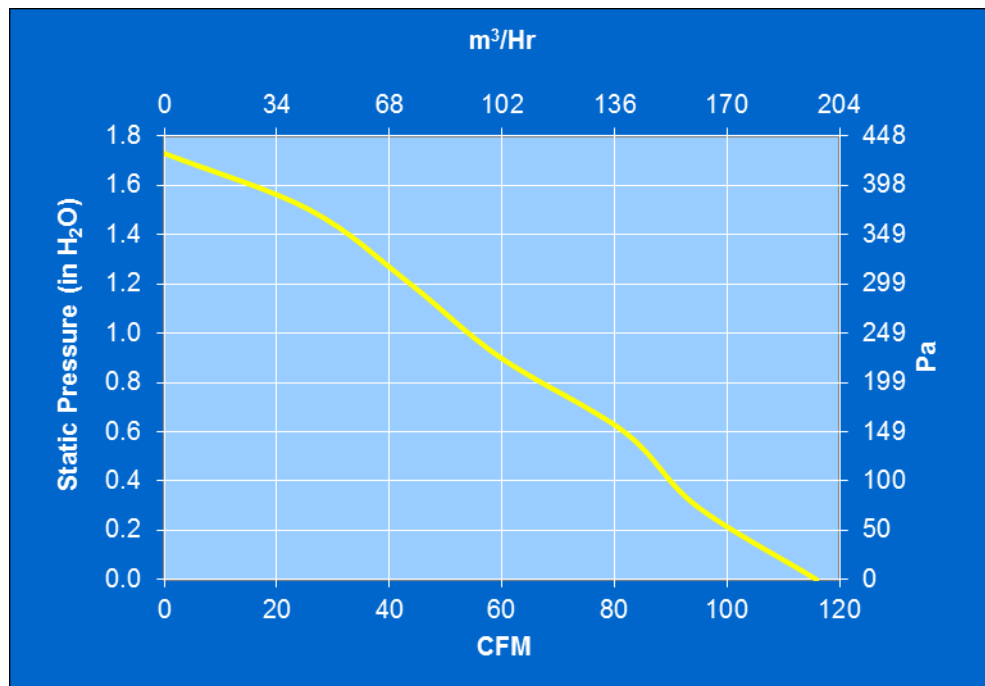

Figure 2

### F.) TERMINATION

LEADWIRES: 304.8mm  $\pm$  25.4mm (12.0"  $\pm$  1.0")  
22 AWG, UL 1061 Style

COLOR DESIGNATION: Red - Power (+)  
Black - Return (-)  
Blue/White - Tachometer Output



## **Comair Rotron Specification Sheet**

Specification Date: Dec 08, 2017

Version: 01

### **H.) RELIABILITY**

This fan is designed for continuous duty life of 52,000 Hours at 40°C, (L10)

### **I.) SAFETY**

UL, CUL, CE

### **J.) Flammability**

The blower including all components meets an UL94V-0 rating or better.